

Bearing No. 60TPS126

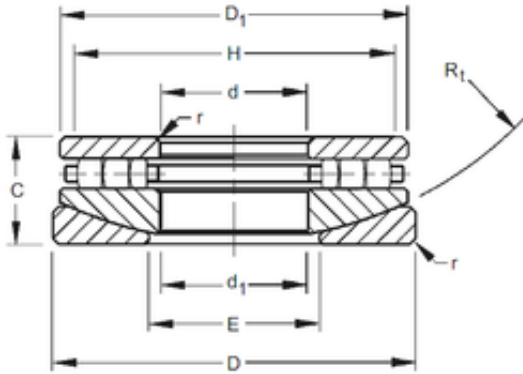

Bore Diameter	152,4 mm
Outer Diameter	292,1 mm
d	152,4 mm
D	292,1 mm
r max	3,2 mm
d1	155,58 mm
C	66,675 mm
D1	277,81 mm
E	187,3 mm
H	265,1 mm
R	342,9 mm